

# Closing Ceremony

By lighting this **green** candle, I am showing how all ethnicities around the world shine. The bright flame represents that our glow of friendship and helpfulness is strong. The wax represents the melting away of issues involving gender, race, age, and ethnicity among us. This candle will unite all races and cultures in friendship, together as one.

We represent the *European Americans* culture by lighting the **pink** candle as we join our friendship together with others.

We represent the *Native Americans* culture by lighting the **purple** candle as we join our friendship together with others.

We represent the *Hispanic and Latino Americans* by lighting the **orange** candle as we join our friendship together with others.

We represent the *African Americans* by lighting the **red** candle as we join our friendship together with others

We represent the *Asian Americans* by lighting the **yellow** candle as we join our friendship together with others

We represent the *Hawaiian or Pacific Islanders* by lighting the **blue** candle as we join our friendship together with others.

I represent all the people uniting together as friends across the world thinking of other cultures, foods, and celebrations on this special day.

I hope everyone has enjoyed learning about the diversity in our world and in the future will be able to approach every day with a new sense of understanding. Though sometimes we look or act different on the outside, we are all the same on the inside. We can maintain harmony with everyone no matter the differences in language, culture, or ethnicity. Thank you for joining us today.

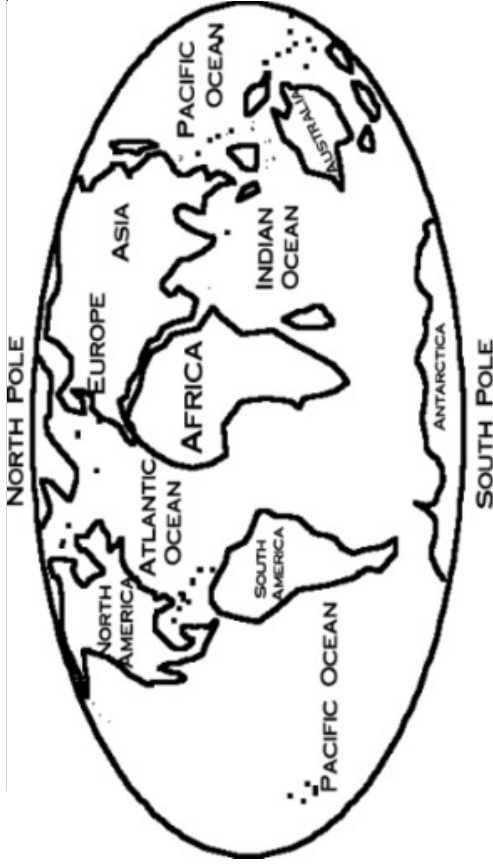

My country for Thinking Day \_\_\_\_\_

## Overview of Thinking Day

My favorite country that I visited \_\_\_\_\_

My favorite activity \_\_\_\_\_

My favorite food \_\_\_\_\_

## My Passport picture (draw a picture)

# AUSTRALIA

Good day mate! Welcome to the land down under! Down under means our country is located below the equator. Hop into a land of boomerangs, kangaroos, and koalas. Our country is located in the continent of Australia.

# SWITZERLAND

Hallo (Hall-O)! That means hello in one of the many languages we speak. Explore the wondrous land of Switzerland, known for the icy Alps, yodeling, lederhosen, chocolate, and their secure bank accounts. mousse. Our country is located in the continent of Europe.

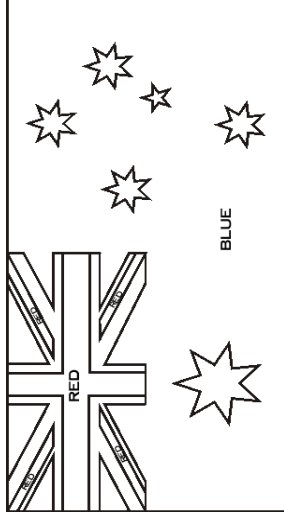

**Activity:**

**Food:**

**Swap:**

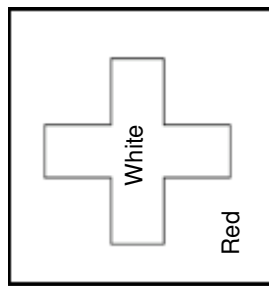

**Activity:**

**Food:**

**Swap:**

# ARGENTINA

Buenos Dias! That means good day in Spanish! Learn about gauchos, [cowboys], eat empanadas or dulce de leche, create a puppet, the Iguazu Falls, macaws, or discover what a tapir or chinchilla looks like. Our country is located in South America.

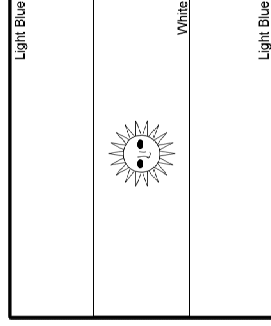

**Activity:**

**Food:**

**Swap:**

# AUSTRIA

Guten Morgan! That means good morning in Austrian! Learn about decorating cows, the Imperial Palace, and the Hochosterwitz castle. Our country is located in Europe.

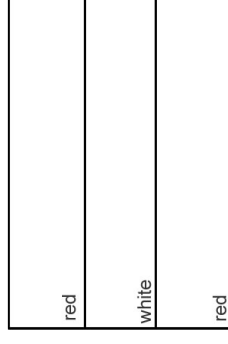

**Activity:**

**Food:**

**Swap:**

# THE BAHAMAS

Hello! Welcome to the Bahamas! Learn more about the Children's Carnival, tropical fruits, and dolphins. Our country is located in the Caribbean.

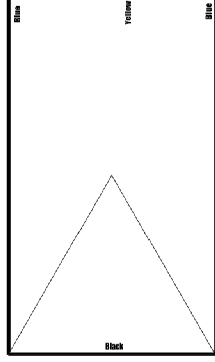

**Activity:**

**Food:**

**Swap:**

# BELGIUM

Hallo! There are many languages spoken in Belgium! Learn more about the Grand Place square in Brussels. It has a variety of flowers placed in front to give the image of a carpet. Learn about clothing, festivals, dances, lace making, cartoon books, and food. Our country is located in Europe.

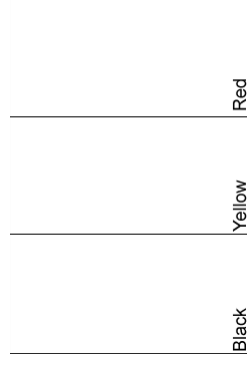

**Activity:**

**Food:**

**Swap:**

# BOLIVIA

Hola! That means hello in Spanish! Learn more about llama, Mayans, ancient civilizations, and the Spanish language. Our country is located in South America.

Red
Yellow
Green

**Activity:**

**Food:**

**Swap:**

# CHILE

Hasta Luego! That means see you later in Spanish! Learn more about Easter Island, Spanish food, the Andes mountains, and the statues there. Our country is located in South America.

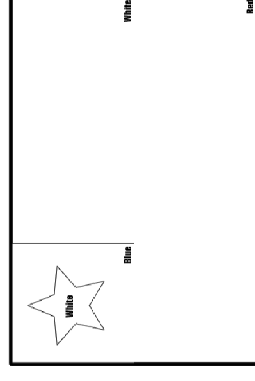

**Activity:**

**Food:**

**Swap:**

# BELIZE

Learn about rainforest animals, archaeological and national parks, marine life, and a tropical adventure. Our country is located in the continent of Central America.

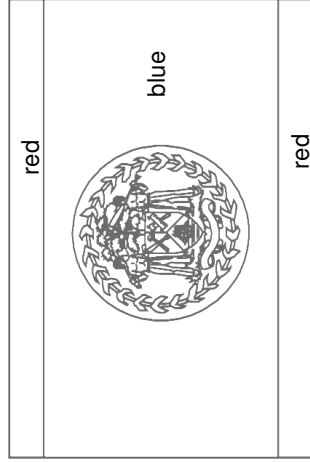

Color the circle white and the ivy around the circle green.

**Activity:**

**Food:**

**Swap:**

# SWEDEN

Hej (hey) ! That means hello in our Swedish language. Indulge in the land called Sweden known for the Kalmar castle, Vikings, St. Lucia holiday, and midsummer poles. Our country is located in the continent of Europe.

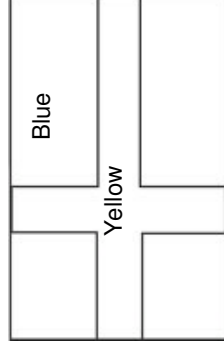

**Activity:**

**Food:**

**Swap:**

# BRAZIL

Alo' (a-loh)! That means hello in our Brazilian language. Venture into the land of the Amazon Rainforest, exotic animals, and the Carnival parade. Our country is located in the continent of South America.

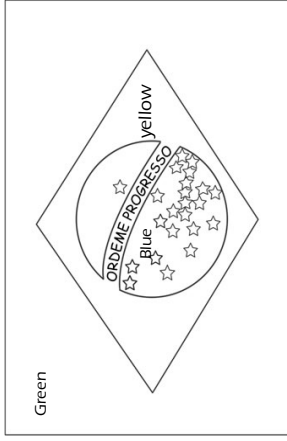

The stars are white.

**Activity:**

**Food:**

**Swap:**

# SPAIN

Bull fighting is famous in Spain. Learn about the breathtaking scenery, guitar playing, flamenco dancing, festivals, the Spanish language, history, and more. Our country is located in the continent of Europe.

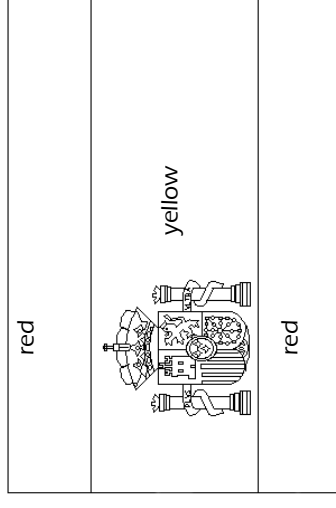

**Activity:**

**Food:**

**Swap:**

# CANADA

Learn about the Niagara Falls through a mist of water, the rainbow bridge, Cave of the Winds, or a wondrous view from mountains and national parks. Our country is located in the continent of North America.

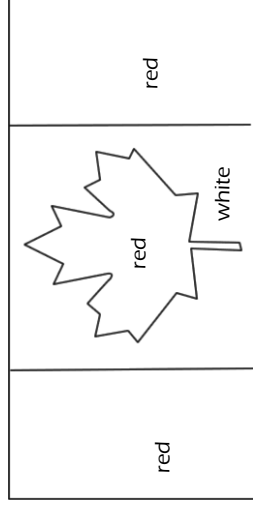

**Activity:**

**Food:**

**Swap:**

# RUSSIA

Russia is known for the Russian ballet, tea ceremonies, Matrioshka, nesting dolls, and St. Basil's Cathedral. Our country is so large it is located in two continents, Asia and Europe.

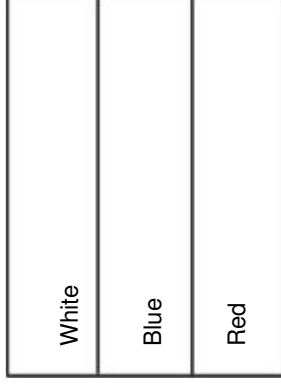

**Activity:**

**Food:**

**Swap:**



# CHINA

Ni Hao (Nee HaOW) ! That means hello in our Chinese language. Did you know that noodles and dumplings originated in China? Cascade into a land of silk, panda bears, and the Great Wall of China. Our country is located in the continent of Asia.

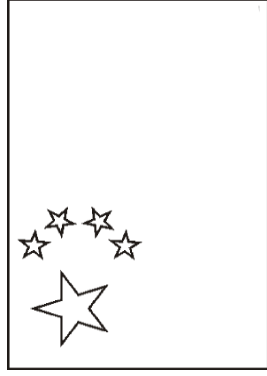

Color the stars yellow and the background red.

**Activity:**

**Food:**

**Swap:**

# THE NETHERLANDS

Hallo! That means hello in Dutch! The Netherlands, frequently called "Holland", is famous for its tulips, wooden shoes, and windmills.

Red
White
blue

**Activity:**

**Food:**

**Swap:**

# COLOMBIA

Hasta Manana! That means see you in the morning in Spanish! Learn about Choco Rainforest, carnivals, Popayan White City, the Cartagena yellow Clocktower and orchids. Our country is located in South America.

yellow
blue
red

**Activity:**

**Food:**

**Swap:**

# COSTA RICA

Adios! That means goodbye in Spanish! Learn more about rainforests, Spanish food, leopards, frogs, and canicas. Our country is located in Central America.



**Activity:**

**Food:**

**Swap:**

# DENMARK

Goddag! That means hello in Danish! Learn more about Legos®, The Little Mermaid®, Hans Christian Andersen, Danish Christmastime, and Danish food. Learn about the brightly painted houses and the Copenhagen mermaid statue. Our country is located in Europe.

**Activity:**

**Food:**

**Swap:**

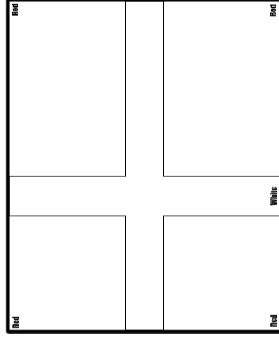

# ECUADOR

Como estas? That means how are you? In Spanish! Learn more about the Galapagos Islands. Ecuador is one of the oldest civilizations in South American. There is a large variety of animal life found in there including a giant tortoise, colorful toucan, oecary or guinea pig. Our country is located in South America.

**Activity:**

**Food:**

**Swap:**

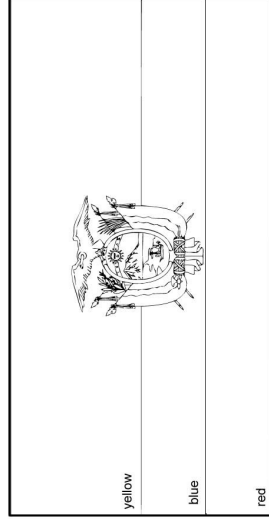

# EGYPT

Ismi (ISS- mee) ! That means hello in our Arabic language. Come explore the mystery and wonder of the ancient land of Egypt. A land of gold jewelry, hidden treasures, and ancient tombs. Our country is located on Africa and Asia. It is mainly located on Africa.

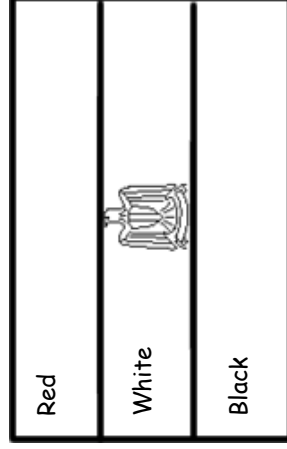

The eagle is a golden-yellow color.

**Activity:**

**Food:**

**Swap:**

# MEXICO

Hola ! That means hello in our Spanish language. Explore Mexico, the land of fiestas, mural paintings, sombreros, ponchos, paper flowers, tambourines, pinch pots. Our country is located in Central America.

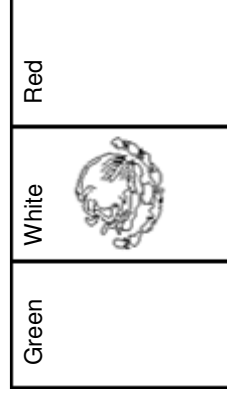

The eagle is brown.

**Activity:**

**Food:**

**Swap:**

# ENGLAND

Good day! Step into England, the land of princesses, double-decker buses, Big Ben, and castles. Our country is located in the continent of Europe.

# KOREA

Did you know the Korean alphabet, hangul, is made up of characters? Learn about Shampoo Day, traditional clothing, swinging, kites, and more. Our country is located in the continent of Asia.

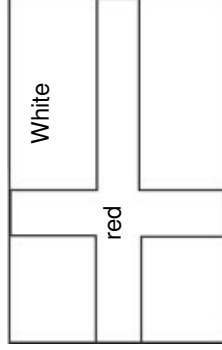

**Activity:**

**Food:**

**Swap:**

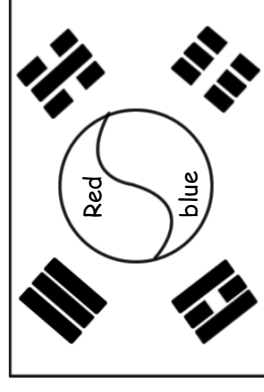

This flag is for South Korea.  
It has a white background.

**Activity:**

**Food:**

**Swap:**

# FIJI

Bula! That means hello in Fijian! The waters of Fiji are home to some of the most beautiful coral reefs in the world. Divers have named the reefs "Soft Coral Capital of the World". Our country is located in the Caribbean.

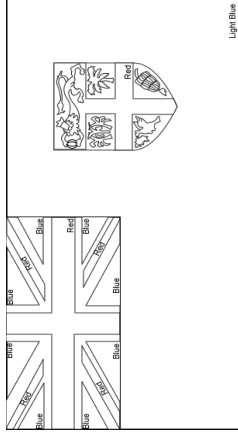

**Activity:**

**Food:**

**Swap:**

# FINLAND

Paivaa! That means hello in Finnish! Learn about folk dances, snow castles, reindeers and the northern lights. About one-third of the land in Finland is located north of the Arctic Circle. Every year a snow castle is built with light-effects and ice-sculpting. It also has a restaurant and various other sections of the castle to review. Our country is located in Europe.

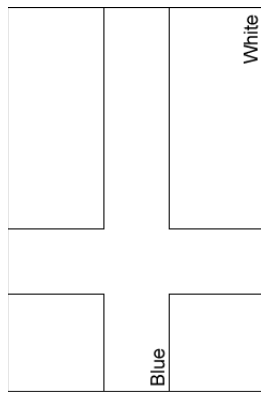

**Activity:**

**Food:**

**Swap:**

# FRANCE

France is known for its wondrous cuisine. Learn about the Eiffel Tower, Monet, and gargoyles. Our country is located in the continent of Europe.

# JAPAN

Konnichiwa (koh knee chee wah) ! That means hello in our Japanese language. Step into Japan, the land of Origami, the Noh theatre, tea ceremonies, calligraphy, kimonos, flower arranging, and karate. Our country is located in the continent of Asia.

blue	white	red
------	-------	-----

**Activity:**

**Food:**

**Swap:**

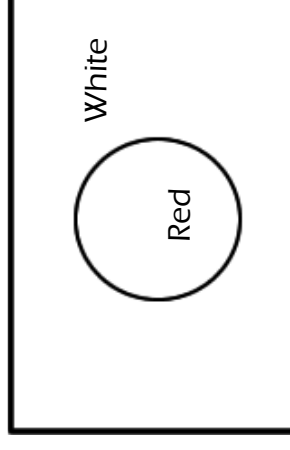

**Activity:**

**Food:**

**Swap:**

# GERMANY

Guten Tag ( GOO– ten tawg ) ! That means hello in our German language. Explore Germany, the land of many castles, the Sleeping Beauty fairy tale, life candles, and gingerbread houses. Our country is located in the continent of Europe.

**Activity:**

**Food:**

**Swap:**

# JAMAICA

venture into an island filled with beaches, waterfalls, and exotic flowers. Our country is located in the continent of North America.

**Activity:**

**Food:**

**Swap:**

Black
Red
Yellow

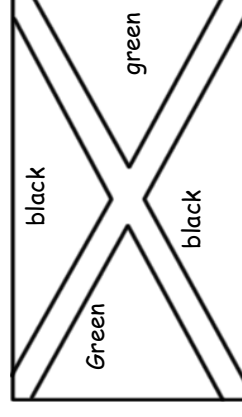

Color the X in the middle yellow.



# GHANA

Did you know Ghana used to be a colony of Britain? Learn about the people, culture, marvel at a canopy bridge overlooking the rain forest, and more. Our country is located in the continent of Africa.

Red
 yellow
green

**Activity:**

**Food:**

**Swap:**

# ITALY

Buon giorno (BWAWN JOHR-noh) ! That means hello in our Italian language. Indulge in the rich culture of Italy and ancient Rome, Italian ice cream, homemade pizza, carnival masks, stained glass windows, paper quilling, and volcanoes. Our country is located in the continent of Europe.

green
white
red

**Activity:**

**Food:**

**Swap:**

# GREECE

Gia (g-i-aw) ! That means hello in our Greek language. Step into the land of Greece, where the Olympics originated, mosaic art, knucklebones, ceramic pots, and victory wreaths. Our country is located in the continent of Europe.

blue	blue
white cross	white
	blue
	white
	blue
	white
	blue
	White
	blue

**Activity:**

**Food:**

**Swap:**

# IRELAND

Top of the morning to you! That was a historical greeting in old English. We also speak the Gaelic language. While exploring the rich history and vibrant culture of the Emerald Isle, Ireland, its mysterious castles, myths and fairytales are sure to amaze you. Our country is located in the continent of Europe.

green	white	orange
-------	-------	--------

**Activity:**

**Food:**

**Swap:**

# GUATEMALA

Como te llamas? That means "what is your name?" in Spanish! Learn about the Mayan city of Tikal, jungles, pyramids, spider monkeys, and the quetzal. Our country is located in Central America.

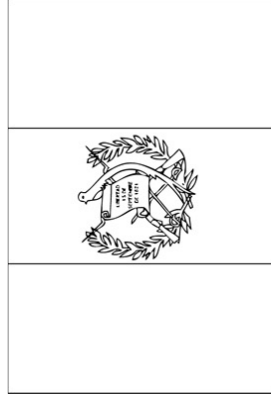

**Activity:**

**Food:**

**Swap:**

# GUYANA

Me llamo...that means "My name is..." in Spanish! Learn about exotic birds, waterfalls, the Spanish language, and yummy food! Our country is located in South America.

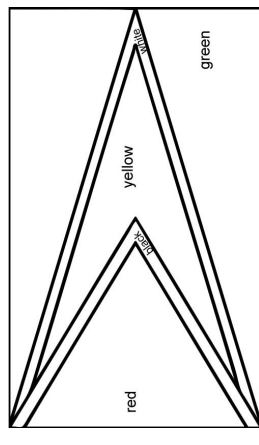

**Activity:**

**Food:**

**Swap:**

# HAITI

Bonjour! That means hello in French! Haiti is a Caribbean country located near the Dominican Republic. Learn more about creole language and music, tap tap trucks, and The Citadelle Laferrière. It is a large mountaintop fortress located in northern Haiti and the most popular historical attraction in Haiti. It took more than a decade and the labor of more than 20,000 workers to build. Our country is located in the Caribbean.

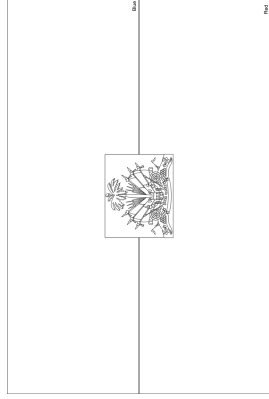

**Activity:**

**Food:**

**Swap:**

# HONG KONG

Ni Hao! That means hello in Cantonese! Learn more about fireworks, dragons, festivals, Hong Kong boats, Chinese opera, and how it's British infused. Our country is located in Asia.

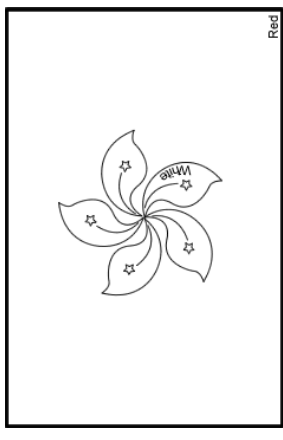

**Activity:**

**Food:**

**Swap:**

# ICELAND

Gooan Daginn! That means hello in Icelandic! Iceland is located south of the Arctic Circle. Even though it is named Iceland only a small percentage of the land is icy. Pictured on the patch is a puffin on a glacier. Our country is located in Europe.

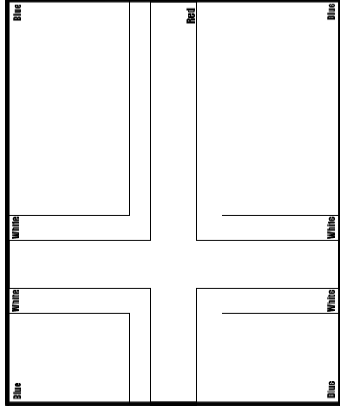

**Activity:**

**Food:**

**Swap:**

# INDONESIA

Salamat! That means hello in Indonesian! An unique building called the Pura Ulun Danu Bratan was built on the water in 1633. Learn about the wildlife, games, food and beautiful clothing and accessories. Our country is located in Asia.

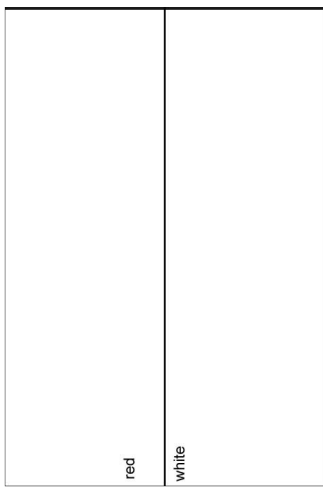

**Activity:**

**Food:**

**Swap:**

# INDIA

Namaste (Nah-mah-stay) ! That means hello in our Hindi language. Explore India, the country of icy treats, henna and kolam designs. Our country is located in the continent of Asia.

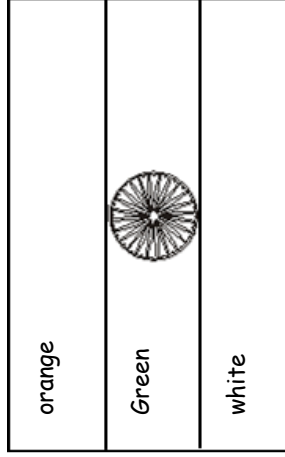

Symbol in the middle is blue.

**Activity:**

**Food:**

**Swap:**

# ISRAEL

Shalom! That means hello in Israel! Venture into Jerusalem, play dreidel, and taste challah bread. Our country is located in the Middle East.

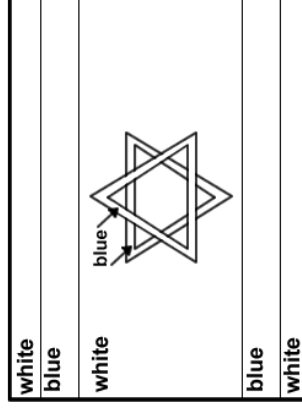

**Activity:**

**Food:**

**Swap:**

# IVORY COAST

Merci! That means thank you in French! Learn more about French language, soccer, African music, elephants, and Ivory Coast food. Our country is located in Africa.

# JORDAN

Marhaba! That means hello in Arabic! Learn more about desert castles, camels, Arabic language, and great food! Our country is located in the Middle East.

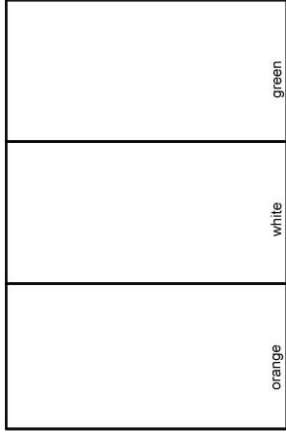

**Activity:**

**Food:**

**Swap:**

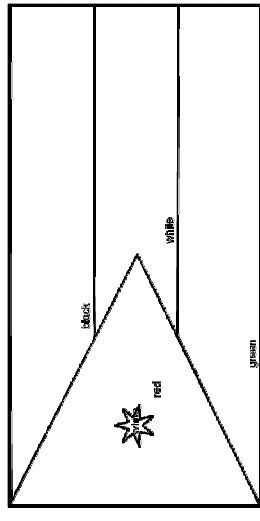

**Activity:**

**Food:**

**Swap:**

# KENYA

Exotic animals grazing in the sunset, ceremonial dances, and handmade crafts. Our country is located in the continent of Africa.

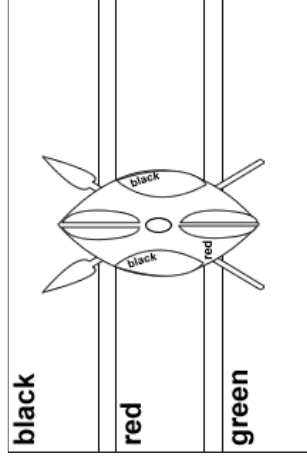

**Activity:**

**Food:**

**Swap:**

# SCOTLAND

The land of kilts, tartan and bagpipes. Castles that kings and queens visit and the land of the Loch Ness monster. Our country is located in the continent of Europe.

All other areas are left white.

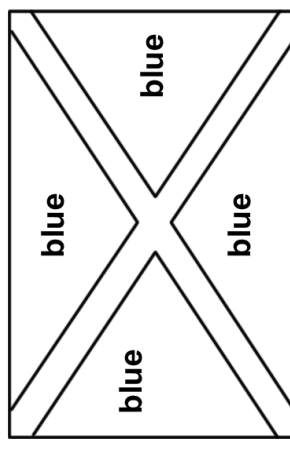

**Activity:**

**Food:**

**Swap:**



# MADAGASCAR

Manao ahoana! That means hello in Malagasy! Learn more about lemurs and other animals from Madagascar, the Malagasy language, unique festivals, and great food! Our country is located off the coast of Africa.

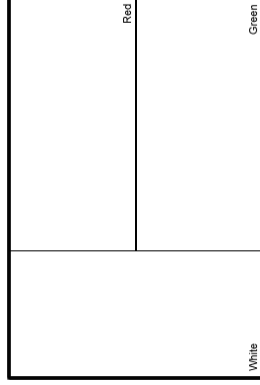

**Activity:**

**Food:**

**Swap:**

# NEW ZEALAND

Kia ora! That means hello in Maori! Did you know that everyone in New Zealand speaks English? Learn more about the Maori tribes, kiwi birds, and their unique lives. Our country is located on the continent of Australia.

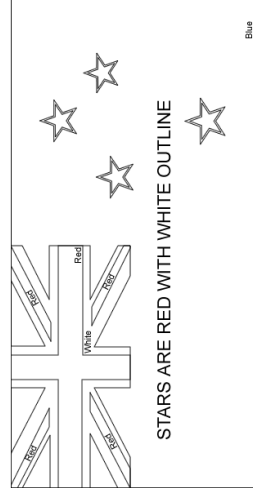

**Activity:**

**Food:**

**Swap:**

# NICARAGUA

Adios amigo! That means goodbye friend in Spanish! Learn about jungles, the three-toed sloth, armadillos, guardabarrancos, and volcanoes. Our country is located in Central America.

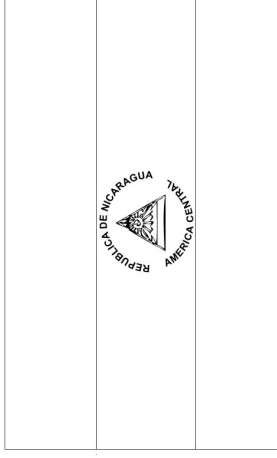

**Activity:**

**Food:**

**Swap:**

# NIGERIA

E ku aaro! That means hello in Yoruba! Most Nigerians buy their food at an open market. Learn more about the farmer's coming to town with their market items, homemade pottery, indigo dyed cloth, gris gris, and the great food they offer. Our country is located in Africa.

Green	White	Green

**Activity:**

**Food:**

**Swap:**

# NORWAY

Hei! That means hello in Norwegian! Learn more about dog sledding, Vikings, reindeers, and the Northern Lights. Our country is located in Europe.

**Activity:**

**Food:**

**Swap:**

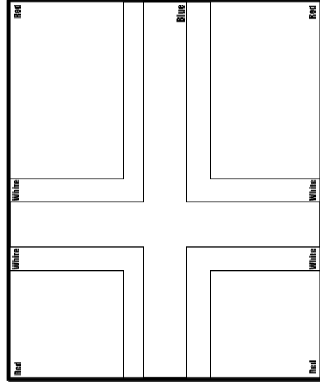

# PERU

Gracias! That means thank you in Spanish! Learn more about Machu Picchu, llamas, Spanish food, sapo game, celebrate festivals, and enjoy Peruvian food. Our country is located in South America.

**Activity:**

**Food:**

**Swap:**

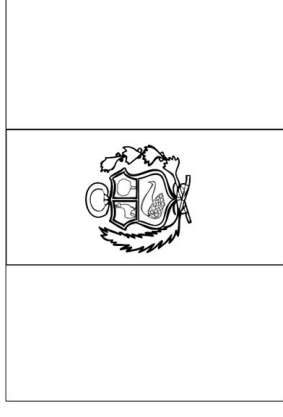

# THE PHILIPPINES

Halo! That means hello in Tagalog! Learn more about the Cebu Taoist, a pagoda shaped building with a large dragon statue in the front, the Tagalog language, kite flying, and Filipino festivals. Our country is located in Asia.

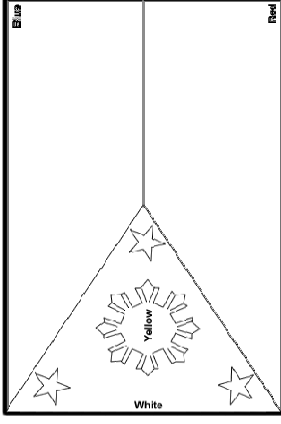

**Activity:**

**Food:**

**Swap:**

# POLAND

Dzien dobry! That means hello in Polish! Learn more about paper cutting, paper ribbons, Christmastime, and eat Polish food. Our country is located in Europe.

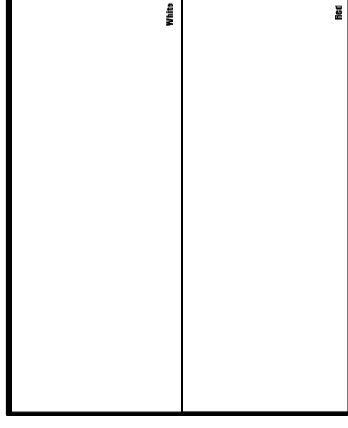

**Activity:**

**Food:**

**Swap:**

# PORTUGAL

Ola! That means hello in Portuguese! Learn about the National Palace, tile painting, bull fighting, and the Rose Festival. Our country is located in Europe.

# TAHITI

Ia ora na! That means hello in Tahitian! Learn more about tikis, island life, handicrafts, and enjoy great tropical drinks and food! Our country is located in the Pacific.

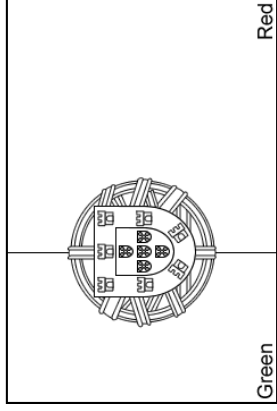

**Activity:**

**Food:**

**Swap:**

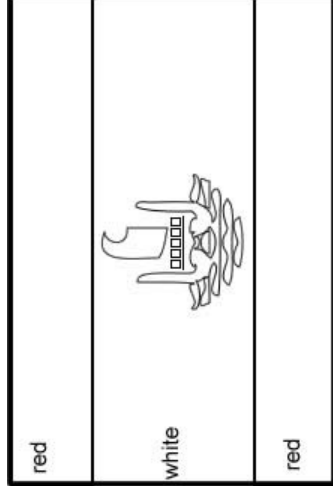

**Activity:**

**Food:**

**Swap:**

Add information about additional rotations, special guests, recognitions, etc.

# SOUTH AFRICA

Learn about different languages, animals, and dances. Our country is located in the continent of Africa.

All other areas are left white.

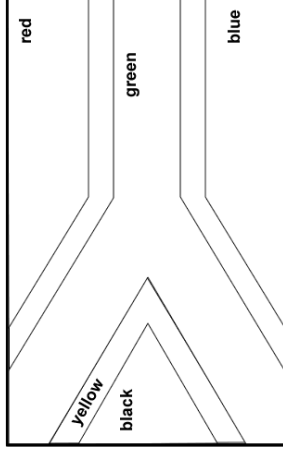

**Activity:**

**Food:**

**Swap:**

# TAIWAN

Ni Hao! That means hello in Mandarin! Enter through the dragon bridge and exit through the tiger and all your bad luck will be forgotten. The pagodas and bridges are located on Lotus Pond. Our country is located in Asia.

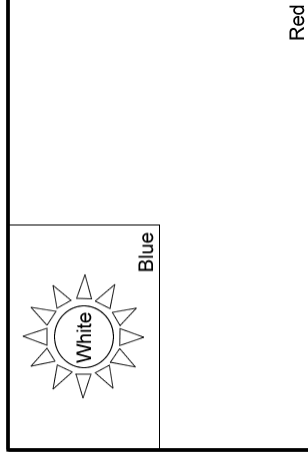

**Activity:**

**Food:**

**Swap:**

# THAILAND

Sawatdi! That means hello in Thai! Learn more about the Royal Palace, Barges, misty mountains, The Royal Thai Company, headresses, beautiful elephants and Thai food. Our country is located in Asia.

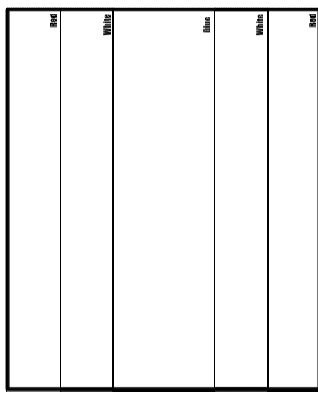

**Activity:**

**Food:**

**Swap:**

# TONGA

Malo e leilei! That means hello in Tongan! Learn more about seals, island life, marine animals, and beaches. Our country is located in the Pacific island area.

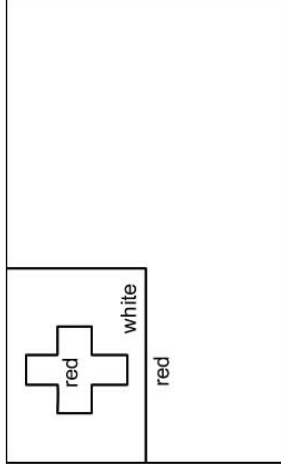

**Activity:**

**Food:**

**Swap:**

# TUNISIA

Merhabtayn! That means hello in Arabic! Learn more about the Sidi Bou Said. Learn about the animals, culture and buildings and blue decorative doors in Tunisia. Our country is located in the Middle East / Northern African area.

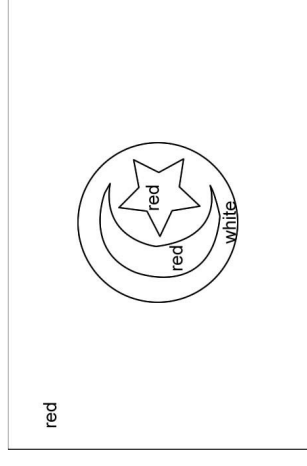

**Activity:**

**Food:**

**Swap:**



# TURKEY

Selam! That means hello in Turkish! Learn more about puppets, Turkish rugs and coffee, marketplaces, shish kabobs, and dances. Our country is located in Europe / Middle East.

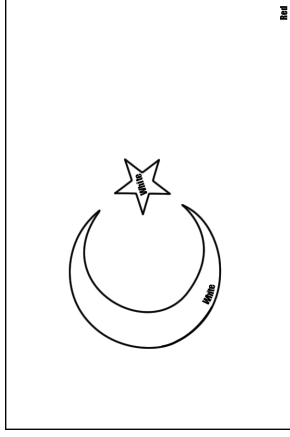

**Activity:**

**Food:**

**Swap:**

# USA

Hello! Welcome to America! Learn about Independence day, Memorial day, eat red, white, and blue food, and learn about the different types of civilizations in America. The "land of the free and the home of the brave" is also home to many interesting historical facts and wonders. Learn about wig wags, butter churning, Sioux, Grand Canyon, Kitty Hawk, Empire State Building, peanut butter, and the sequoia trees. Our country is located in North America.

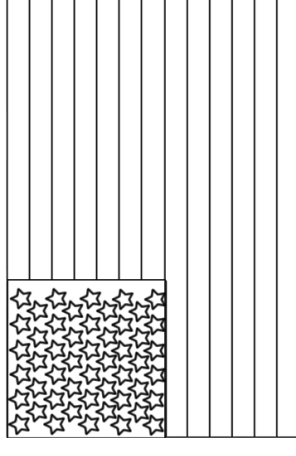

**Activity:**

**Food:**

**Swap:**

# VIETNAM

Chao! That means hello in Vietnamese! Learn more about pagodas, great food, jungle tress, traditional architecture, and the language. Our country is located in Asia.

# WALES

Dydd da! That means hello in Welsh! Learn more about castles, poppies, dragons, legends, and enjoy Welsh food. Our country is located in Europe.

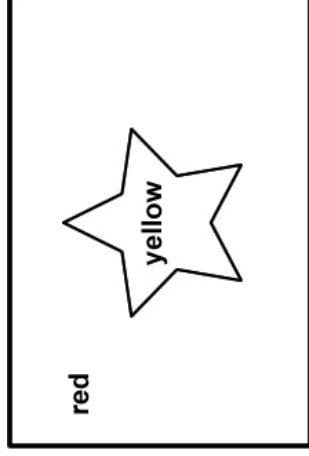

**Activity:**

**Food:**

**Swap:**

The dragon is red

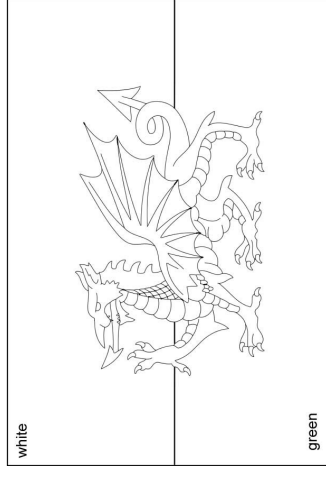

**Activity:**

**Food:**

**Swap:**

COMMUNITY SERVICE

BAKE-OFF

Activity:

Favorite Foods: